



HMC786LP4E

BiCMOS MIXER W/ INTEGRATED LO AMPLIFIER, 700 - 1100 MHz

Typical Applications

The HMC786LP4E is Ideal for:

- Cellular/3G & LTE/WiMAX/4G
- Basestations & Repeaters
- GSM, CDMA & OFDM
- Transmitters and Receivers

Features

- High Input IP3: +40 dBm
- 7.5 dB Conversion Loss @ 0 dBm LO
- Optimized for High Side LO Input
- Adjustable Supply Current
- 24 Lead 4x4mm SMT Package: 16mm²

Functional Diagram

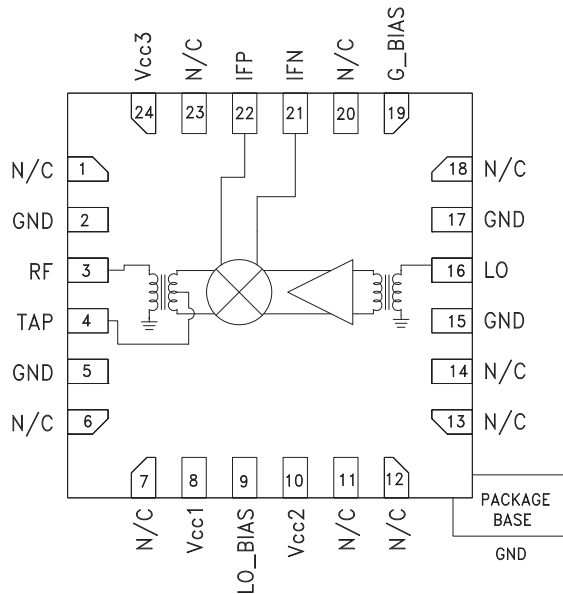

General Description

The HMC786LP4E is a high dynamic range passive MMIC mixer with integrated LO amplifier in a 4x4 SMT QFN package covering 0.7 to 1.1 GHz. Excellent input IP3 performance of +40 dBm for down conversion is provided for 3G & 4G GSM/CDMA applications at an LO drive of 0 dBm. With an input 1 dB compression of +25 dBm, the RF port will accept a wide range of input signal levels. Conversion loss is 7.5 dB typical. Up to 250 MHz IF frequency response will satisfy GSM/CDMA transmit or receive frequency plans. The HMC786LP4E is optimized for high side LO frequency plans for 0.7 - 1.1 GHz RF Band and is pin for pin compatible with the HMC686LP4E

Downconverter Electrical Specifications,

$T_A = +25^\circ C$, LO = 0 dBm, Vcc = Vcc1, 2, 3 = +5V, G_Bias = +2.5V *

Parameter	Min.	Typ.	Max.	Min.	Typ.	Max.	Units
Frequency Range, RF		0.7 - 1.1		0.824 - 0.915			GHz
Frequency Range, LO		0.75 - 1.35		0.974 - 1.065			GHz
Frequency Range, IF		50 - 250		150			MHz
Conversion Loss		7.5	9.5	7.5	9.5		dB
Noise Figure (SSB)		7.5		7.5			dB
IP3 (Input)		36		40			dBm
1 dB Compression (Input)		26		27			dBm
LO to RF Isolation	18	24		18	23		dB
LO to IF Isolation	23	30		23	30		dB
RF to IF Isolation	25	39		30	40		dB
LO Drive Input Level (Typical)		-6 to +6		-6 to +6			dBm
Supply Current (Icc total)		160	180	160	180		mA

* Unless otherwise noted all measurements performed as downconverter with high side LO & IF = 150 MHz.



**BiCMOS MIXER W/ INTEGRATED
LO AMPLIFIER, 700 - 1100 MHz**

Upconverter Electrical Specifications,

$T_A = +25^\circ\text{C}$, LO = 0 dBm, Vcc = Vcc1, 2, 3 = +5V, G_Bias = +2.5V *

Parameter	Min.	Typ.	Max.	Min.	Typ.	Max.	Units
Frequency Range, RF	0.7 - 1.1		0.860 - 0.960				
Frequency Range, LO	0.75 - 1.35		0.980 - 1.080				
Frequency Range, IF	50 - 250		120				
Conversion Loss		7.5	9.5		7.5	9.5	dB
IP3 (Input)		36			41		dBm
1 dB Compression (Input)		24			24		dBm
LO Drive Input Level (Typical)	-6 to +6		-6 to +6				
Supply Current (Icc total)		160	180		160	180	mA

*Unless otherwise noted all measurements performed as upconverter with high side LO & IF = 120 MHz.

Downconverter Performance

Conversion Gain vs. Temperature

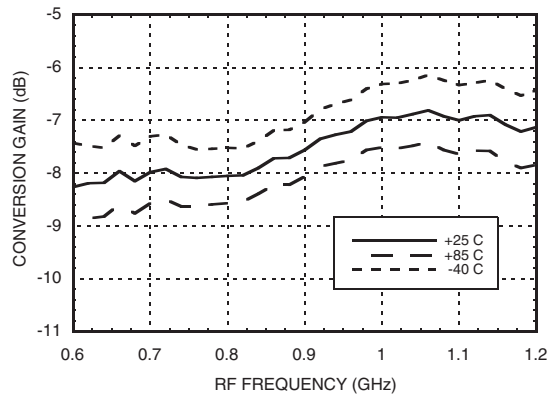

Conversion Gain vs. LO Drive

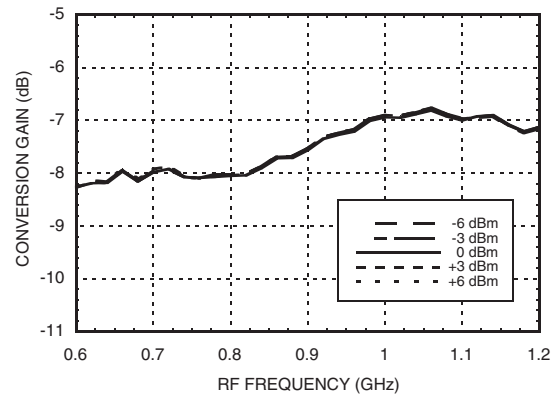

Conversion Gain vs. Icc

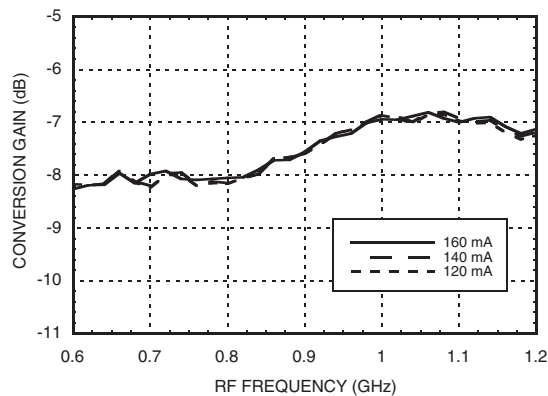

Conversion Gain vs. G_Bias Voltage

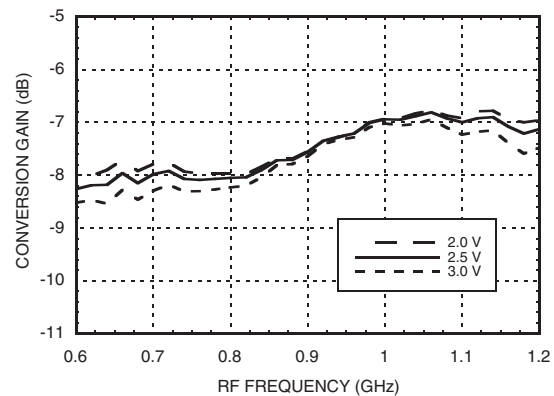

Downconverter Performance

Conversion Gain vs. IF Frequency

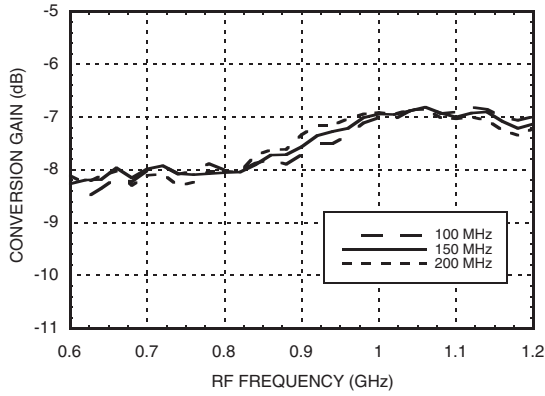

IF Bandwidth (LO = 1.1 GHz)

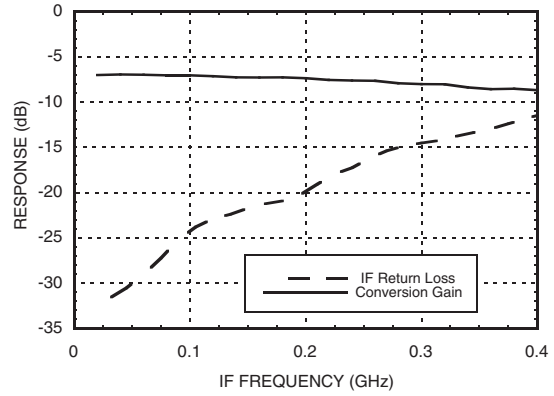

Input IP3 vs. Temperature [1]

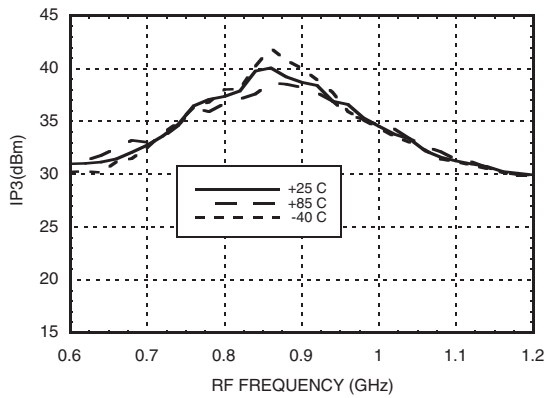

Input IP3 vs. LO Drive [1]

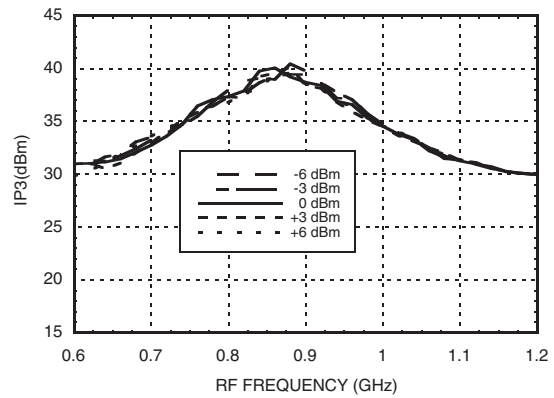

Input IP3 vs. Icc [1]

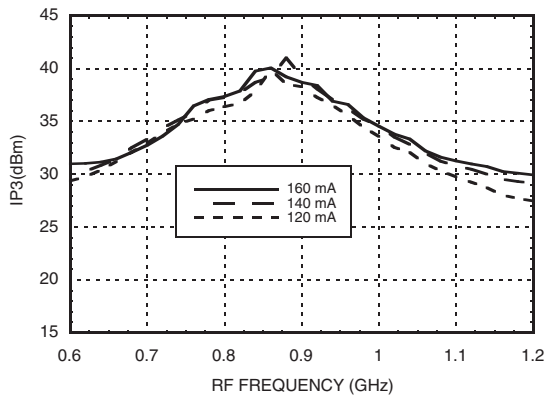

Input IP3 vs. G_Bias Voltage [1]

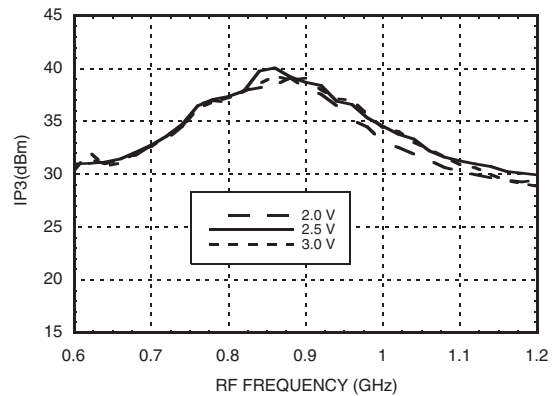

Downconverter Performance

Input IP3 vs. IF Frequency [1]

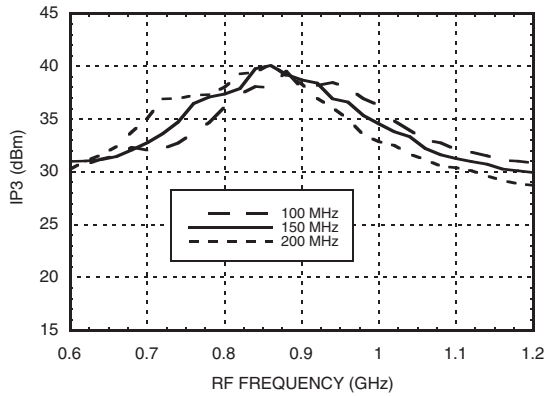

Input P1dB vs. Temperature

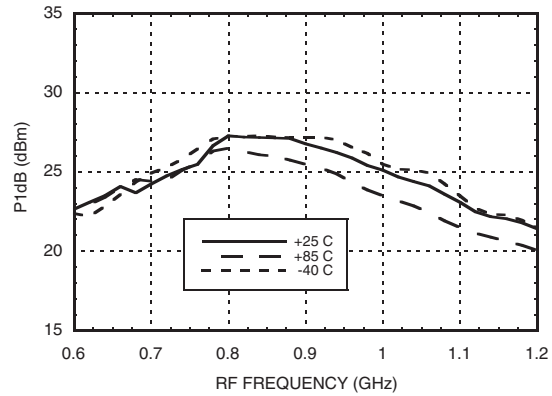

-2RF +2LO Response vs. Temperature [2]

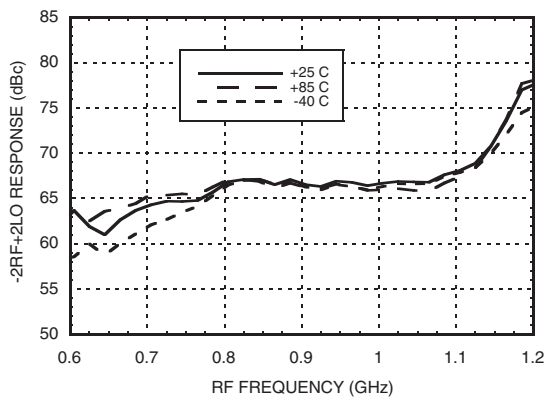

-2RF +2LO Response vs. LO Drive [2]

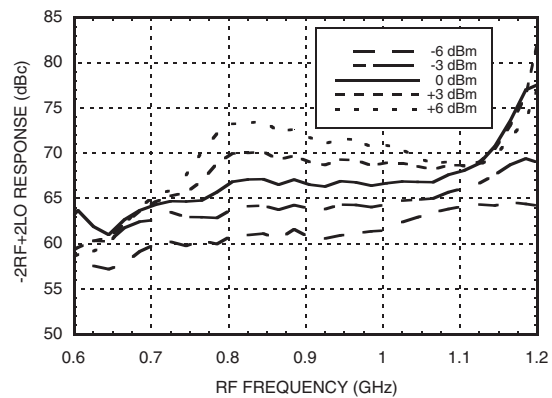

-3RF +3LO Response vs. Temperature [2]

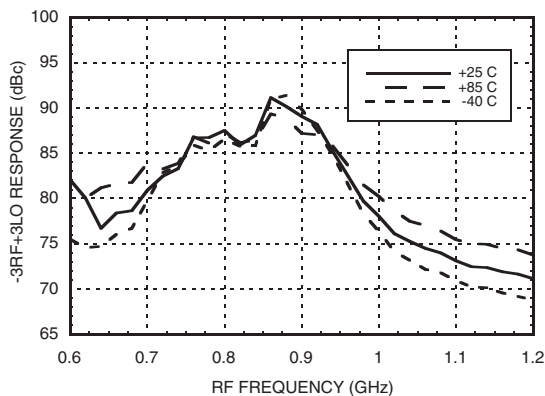

-3RF +3LO Response vs. LO Drive [2]

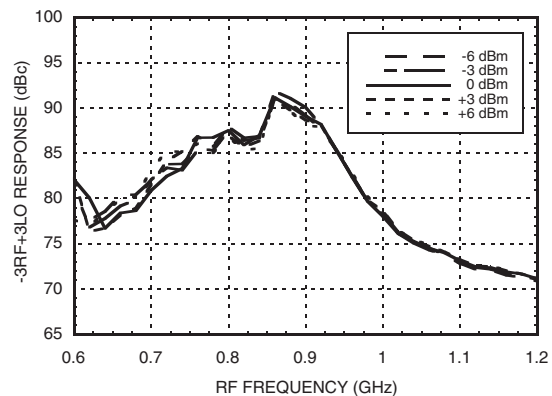

[1] Two-tone input power = +9 dBm each tone, 1 MHz spacing. [2] Referenced to RF Input Power at 0 dBm

BiCMOS MIXER W/ INTEGRATED LO AMPLIFIER, 700 - 1100 MHz

Return Loss

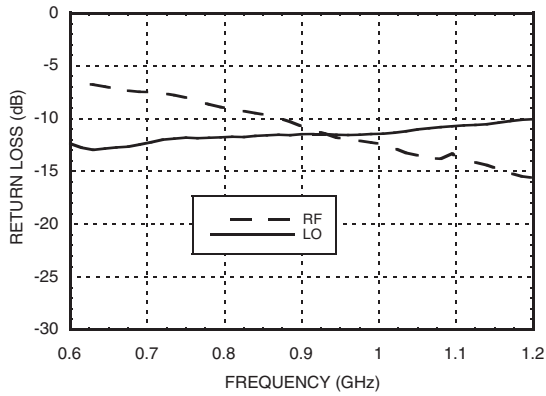

Isolation

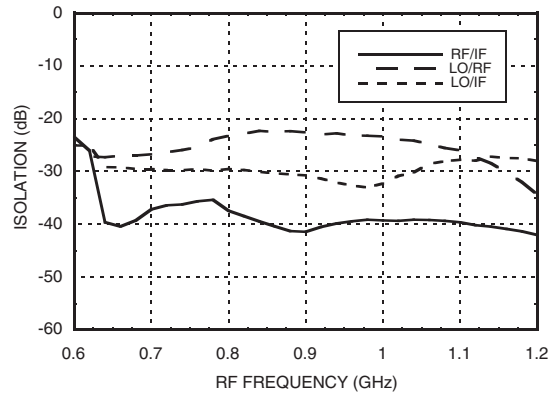

Upconverter Performance

Conversion Gain vs. Temperature

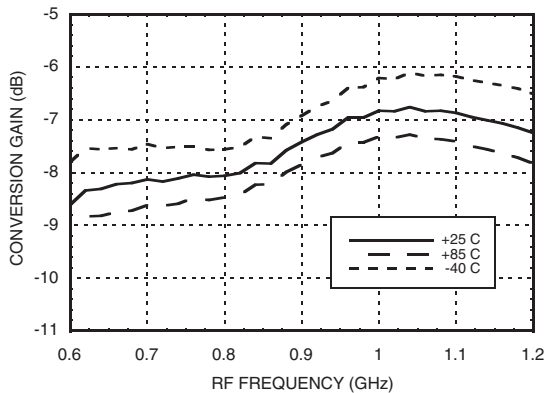

Conversion Gain vs. LO Drive

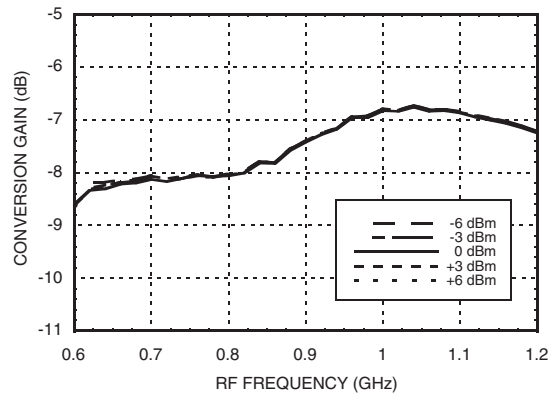

Conversion Gain vs. Icc

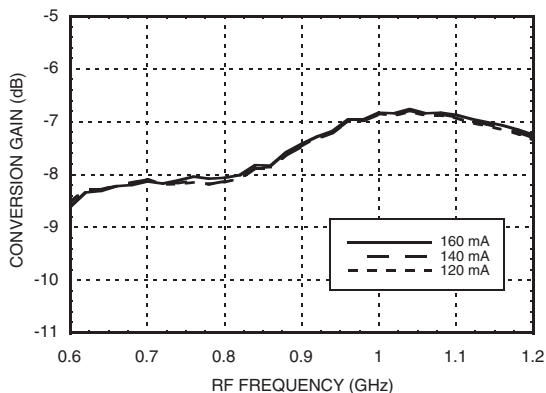

Conversion Gain vs. IF Frequency

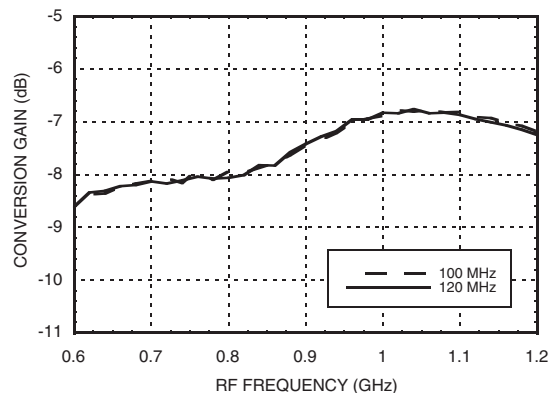

Upconverter Performance

Input IP3 vs. Temperature [1]

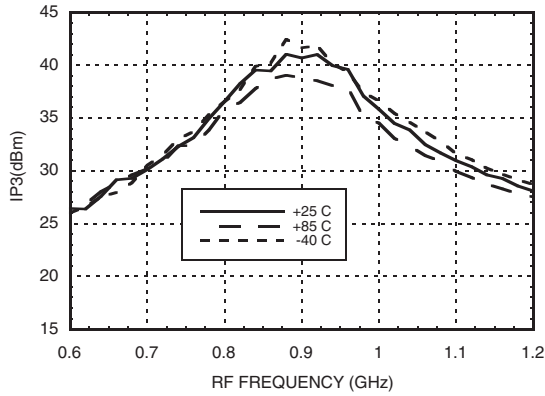

Input IP3 vs. LO Drive [1]

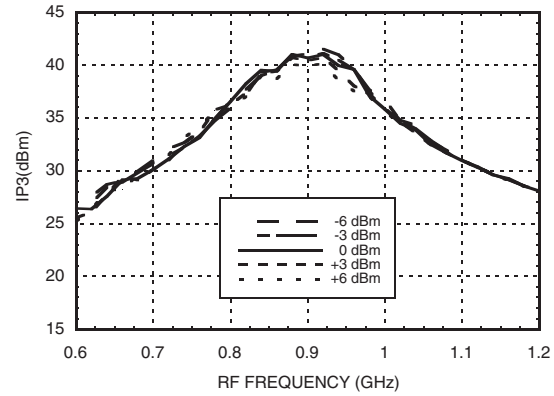

Input IP3 vs. Icc [1]

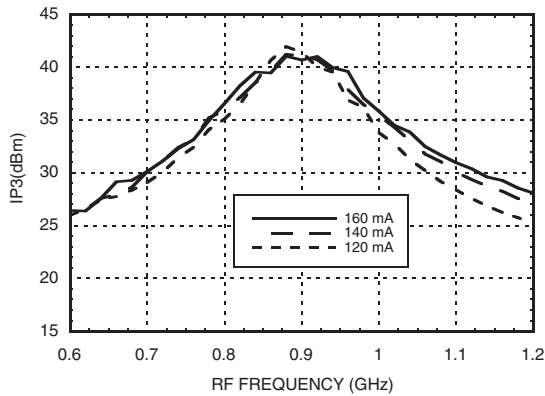

Input IP3 vs. IF Frequency [1]

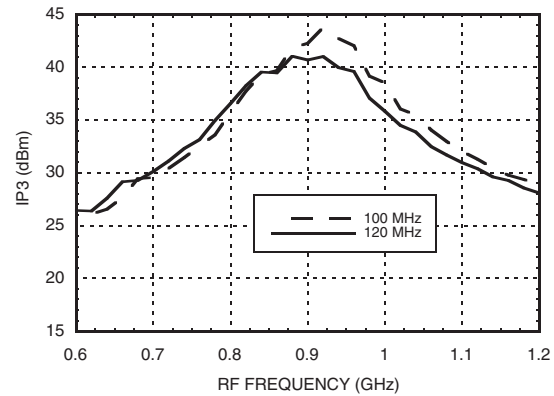

Input P1dB vs. Temperature

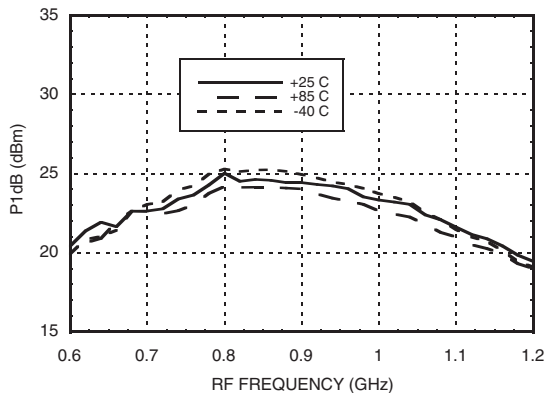

Icc vs. R9

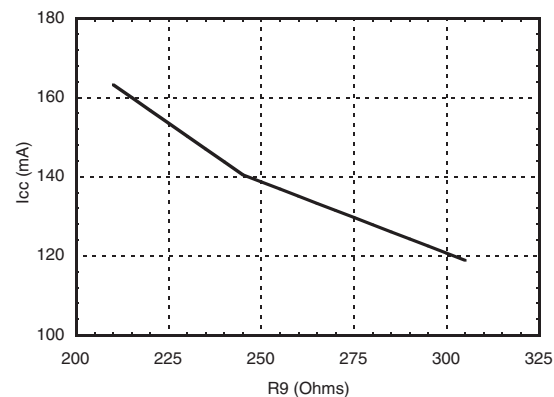

[1] Two-tone input power = +9 dBm each tone, 1 MHz spacing.

BiCMOS MIXER W/ INTEGRATED LO AMPLIFIER, 700 - 1100 MHz

Absolute Maximum Ratings

Vcc1, 2, 3	5.5 V
RF Input Power (Vcc1, 2, 3 = +5V)	+23 dBm
IF Input Power (Vcc1, 2, 3 = +5V)	+20 dBm
LO Drive (Vcc1, 2, 3 = +5V)	+10 dBm
Channel Temperature	125 °C
Continuous Pdiss (T = 85°C) (derate 27 mW/°C above 85°C)	1.0 W
Thermal Resistance (junction to ground paddle)	37 °C/W
Storage Temperature	-65 to 150 °C
Operating Temperature	-40 to +85 °C

Typical Supply Current vs. Vcc

Vcc1, 2, 3 (V)	Icc total (mA)
4.75	147
5.00	160
5.25	172



**ELECTROSTATIC SENSITIVE DEVICE
OBSERVE HANDLING PRECAUTIONS**

Outline Drawing

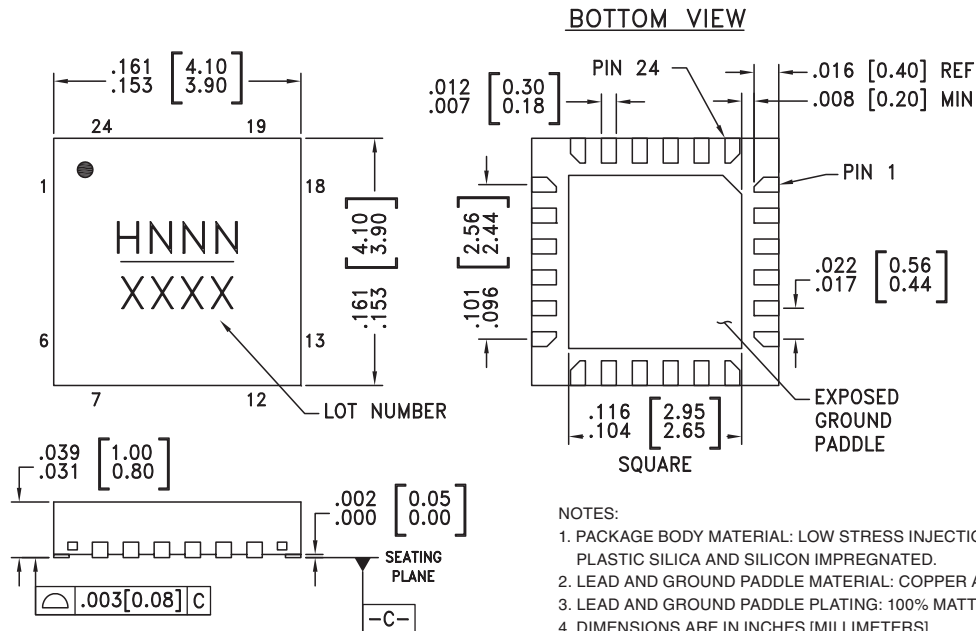

NOTES:

1. PACKAGE BODY MATERIAL: LOW STRESS INJECTION MOLDED PLASTIC SILICA AND SILICON IMPREGNATED.
2. LEAD AND GROUND PADDLE MATERIAL: COPPER ALLOY.
3. LEAD AND GROUND PADDLE PLATING: 100% MATTE TIN.
4. DIMENSIONS ARE IN INCHES [MILLIMETERS].
5. LEAD SPACING TOLERANCE IS NON-CUMULATIVE.
6. PAD BURR LENGTH SHALL BE 0.15mm MAX.
PAD BURR HEIGHT SHALL BE 0.25mm MAX.
7. PACKAGE WARP SHALL NOT EXCEED 0.05mm
8. ALL GROUND LEADS AND GROUND PADDLE MUST BE SOLDERED TO PCB RF GROUND.
9. REFER TO HITTITE APPLICATION NOTE FOR SUGGESTED PCB LAND PATTERN.

Package Information

Part Number	Package Body Material	Lead Finish	MSL Rating	Package Marking ^[2]
HMC786LP4E	RoHS-compliant Low Stress Injection Molded Plastic	100% matte Sn	MSL1 ^[1]	H786 XXXX

[1] Max peak reflow temperature of 260 °C

[2] 4-Digit lot number XXXX

Pin Descriptions

Pin Number	Function	Description	Interface Schematic
1, 6, 7, 11 - 14, 18, 20, 23	N/C	No connection. These pins may be connected to RF ground. Performance will not be affected.	
2, 5, 15, 17	GND	These pins and package bottom must be connected to RF/DC ground.	
3	RF	This pin is matched single-ended to 50 Ohm and DC shorted to ground through a balun.	
4	TAP	Center tap of secondary side of the internal RF balun. Short to ground with a zero Ohms close to the package.	
8, 10, 24	Vcc1, Vcc2, Vcc3	Power supply voltage. See application circuit for required external components.	
9	LO_BIAS	LO buffer current adjustment pin. Adjust the LO buffer current through the external resistor R9 shown in the application circuit (connect 215 Ohms for nominal operation). This adjustment allows for a trade-off between power dissipation and linearity performance of the converter.	
16	LO	This pin is matched single-ended to 50 Ohm and DC shorted to ground through a balun.	
19	G_BIAS	External bias with a nominal value of 2.5V. See application circuit for recommended external components. G_Bias can be set to between 0 and 5Vdc. This adjustment allows for a trade off between conversion loss and linearity performance of the converter (see figures CG, IP3 vs. G_BIAS). The G_bias pin has an internal 15 KOhms resistance to ground and 15 KOhms to Vcc. Internal resistive divider sets 2.5 V for G_bias and can be changed externally.	
21, 22	IFN, IFP	Differential IF input / output pins matched to differential 50 ohms. For applications not requiring operation to DC an off chip DC blocking capacitor should be used.	

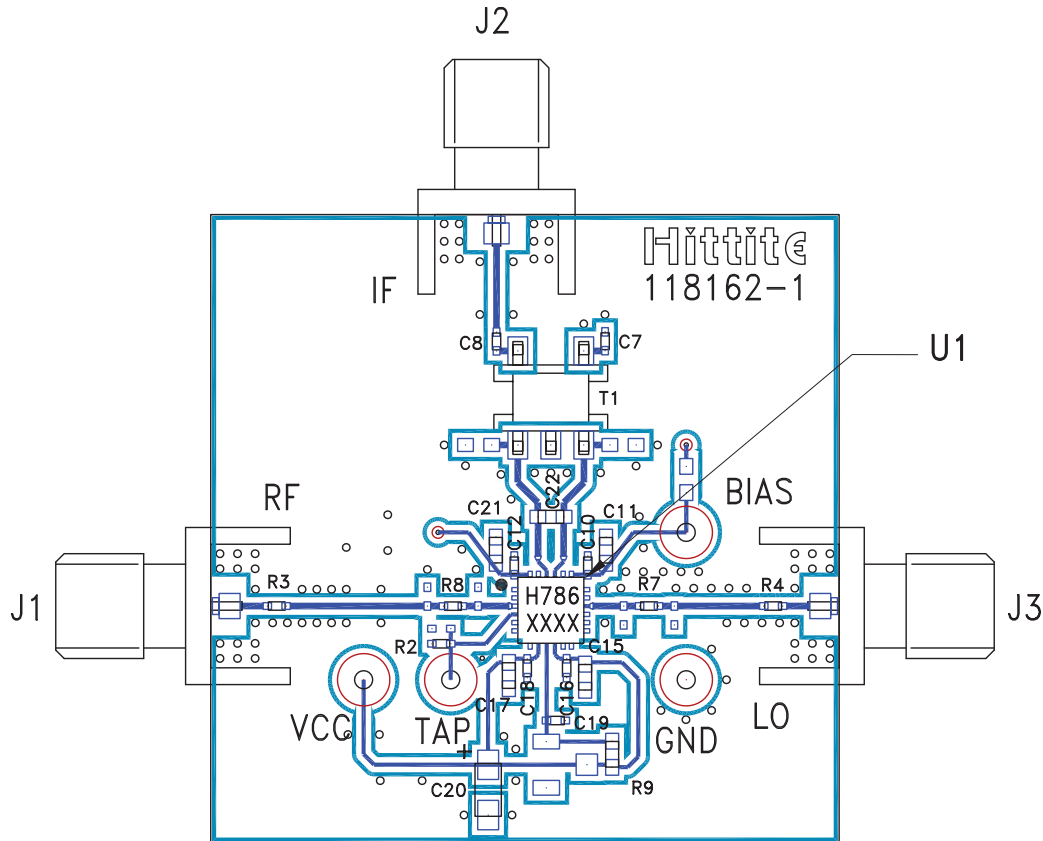
Evaluation PCB

List of Materials for Evaluation PCB 121769 [1]

Item	Description
J1 - J3	SMA Connector
J4 - J7	DC Pin
C7, C8	10 nF Capacitor, 0402 Pkg.
C10, C12, C16, C18	1 nF Capacitor, 0402 Pkg.
C11, C15, C17, C21	0.1 μ F Capacitor, 0402 Pkg.
C19	22 pF Capacitor, 0402 Pkg.
C20	4.7 μ F Case A, Tantalum
C22	1.8 pF Capacitor, 0603 Pkg.
R2 - R4, R7, R8	0 Ohm Resistor, 0402 Pkg.
R9	215 Ohm Resistor, 0603 Pkg.
T1	1:1 Transformer - Tyco MABA CT0039
U1	HMC786LP4E
PCB [2]	118162 Evaluation PCB

[1] Reference this number when ordering complete evaluation PCB

[2] Circuit Board Material: Rogers 4350 or Arlon 25 FR

The circuit board used in the final application should use RF circuit design techniques. Signal lines should have 50 ohm impedance while the package ground leads and exposed paddle should be connected directly to the ground plane similar to that shown. A sufficient number of via holes should be used to connect the top and bottom ground planes. The evaluation circuit board shown is available from Hittite upon request.

Application Circuit

